

Tefal®

EN



1 kg
1.2 kg

ActiFry Original

www.tefal.com

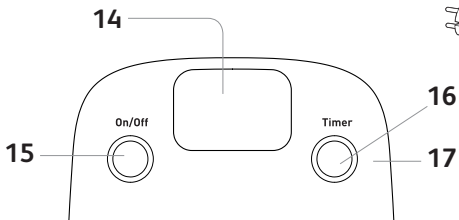
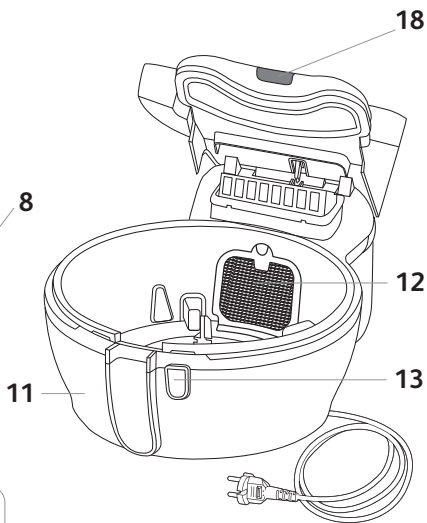
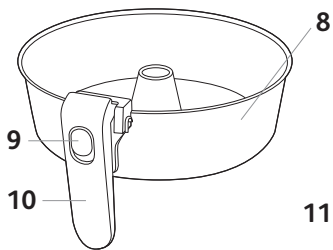
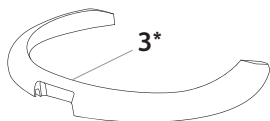
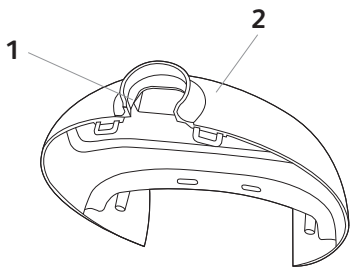
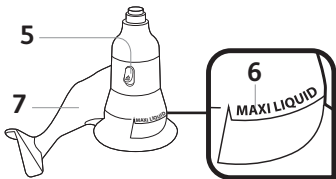

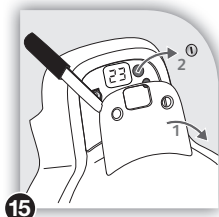
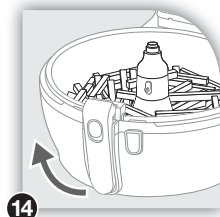
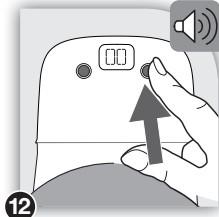
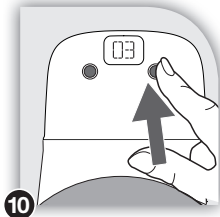
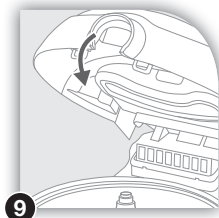
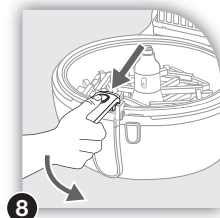
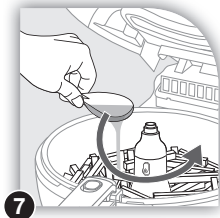
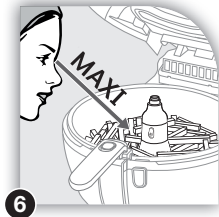
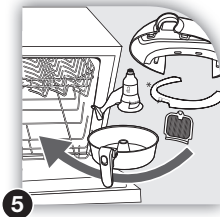
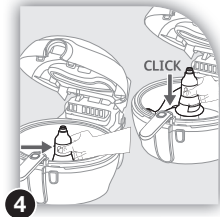
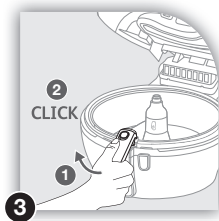
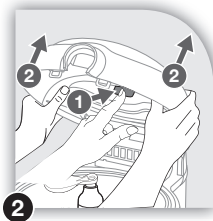
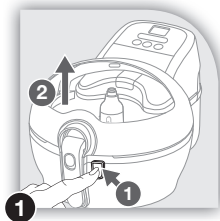

English

Important recommendations

Safety instructions

- This appliance has been designed for internal domestic use only; any professional use which does not conform to the instructions will release the manufacturer from all responsibility and the guarantee will be deemed null and void.
- Read these instructions carefully and keep them in a safe place.
- This appliance is intended for domestic use only.
- This appliance is not intended to be operated using an external timer or separate remote control system.
- Do not use the appliance if it or the power cord is damaged or if it has fallen and has visible damage or appears to be working abnormally. If this occurs, the appliance must be sent to an Approved Service Centre.
- If the power cord is damaged, it must be replaced by the manufacturer, an approved After-Sales Service or a similarly qualified person, in order to avoid any danger. Never take the appliance apart yourself.
- This appliance is not designed to be used by people (including children) with a physical, sensory or mental impairment, or people without knowledge or experience, unless they are supervised or given prior instructions concerning the use of the appliance by someone responsible for their safety. Children must be supervised to ensure that they do not play with the appliance.
- This appliance can be used by children aged from 8 years and above and persons with reduced physical, sensory or mental

capabilities or lack of experience and knowledge if they have been given supervision or instruction concerning use of the appliance in a safe way and understand the hazards involved. Children shall not play with the appliance. Children under the age of 8 years should not use this appliance unless continuous supervision by a responsible adult is given. Cleaning and user maintenance shall not be made by children unless they are older than 8 years and supervised.

Keep the appliance and its cord out of reach of children less than 8 years.

-  Certain parts of the appliance can become hot when the appliance is operating, which could cause burns. Do not touch the hot surfaces of the appliance (the lid, visible metal parts, etc).
- All these removable parts may be cleaned in the dishwasher or with a non-abrasive sponge and washing up liquid.
- Clean the body of the appliance with a damp sponge and washing up liquid.
- Dry the parts carefully before reassembling.
- Children should not clean or perform maintenance procedures on the appliance unless they are supervised by a responsible adult.
- Do not use the appliance close to inflammable materials (blinds, curtains, etc), nor close to an external heat source (gas hob, hotplate, etc).
- This appliance is intended to be used only in the household. It is not intended to be used in the following applications, and the guarantee will not apply for:

- staff kitchen areas in shops, offices and other working environments;
 - farm houses inns,
 - clients in hotels, motels and other residential type environments,
 - bed and breakfast type environments.
- Do not immerse the product in water.
 - Never operate the appliance using the removable cooking pan only and without the mixing blade or the appropriate ACTIFRY accessory.
 - For your safety, this appliance conforms with applicable standards and regulations (Directives on Low Voltage, Electromagnetic Compatibility, Materials in contact with food, Environment, etc.).
 - Check that the voltage of your mains network corresponds to the voltage given on the rating plate on the appliance (alternative current).
 - Given that there are so many different standards, if the appliance is to be used in a country other than that in which it was bought, have it checked by Approved Service Centre.
 - For models with detachable power cords, only use the original power cord.
 - Do not use an extension lead. If you nevertheless decide to do so, under your own responsibility, use an extension lead that is in good condition and compliant with the power of the appliance.
 - Use the appliance on a flat, stable, heat-resistant work surface away from water splashes.
 - Do not let the power cord dangle.
 - Do not unplug the appliance by pulling on the power cord.
 - Always unplug your appliance: after use, to move it, or to clean it.
 - In the event of fire, unplug the appliance and smother the flames using a damp tea towel.
 - Never operate the appliance underneath kitchen cupboards.
 - Never move the appliance when it still contains hot food.
 - Never operate your appliance when empty.
 - Never leave the appliance unattended whilst it is plugged in and switched on.
- When using the product for the first time, it may release a non-toxic odour. This will not affect use and will disappear rapidly.
- Do not overload the cooking pan; stick to the recommended quantities.
- Your appliance is equipped with an automatic turn-over ring (depending on model). This turn-over ring should be used to cook chips. We also recommend using it for recipes that require a large quantity of food. Remove the turn-over ring for liquid recipes, for ease of pouring at the end of cooking.

- **To avoid damaging your appliance, please ensure that you follow the recipes in the instructions and recipe book; make sure that you use the right amount of ingredients.**

Protect the environment

- When you decide to replace the appliance, remember to think about how you can contribute to protecting the environment.
- Before discarding your appliance you should remove the battery from the timer and dispose of it at a local civic waste collection centre (according to model).
- The Approved Service Centres will take back any old appliances you may have so that they can be disposed of in accordance with environmental regulations.

Description

- | | |
|---------------------------------------|--|
| 1. Cool touch area of the lid | 11. Base |
| 2. Lid | 12. Removable filter |
| 3. Turn-over ring * | 13. Lid opening button |
| 4. Measuring spoon (14 ml) | 14. Digital timer |
| 5. Locking/unlocking paddle lever | 15. On/Off switch |
| 6. Maximum level markers (for liquid) | 16. Timer setting button |
| 7. Removable mixing paddle | 17. Removable control panel (for access to the battery compartment only) |
| 8. Removable cooking pan | 18. Button for removing lid |
| 9. Cooking pan handle release button | |
| 10. Cooking pan handle | |

Quick introduction for use

Before first use

- To remove the lid – **fig. 1**, press the lid opening button (13) and push button for removing lid (18) to take off the lid – **fig. 2**. **Remove all the stickers and any packaging.**
- Remove the measuring spoon. **Never immerse the base in water.**
- Lift the handle to a horizontal position until you hear a “click” as it locks.
- Take out the cooking pan – **fig. 3**.
- Remove the ring by releasing the clips from the edge of the pan and pushing it upwards*.
- Remove the paddle by pushing the release button – **fig. 4**. **On first use, to obtain the best results from your new product, we advise you to prepare a recipe that cooks for 30 minutes or more.**
- All the removable parts are dishwasher safe – **fig. 5** or can be washed with a soft sponge and washing up liquid.
- Wipe the base of the appliance using a damp cloth and washing up liquid.
- Rinse and dry the parts carefully before putting them back together.
- Reposition the paddle until you hear the « CLICK » – **fig. 4**.
- During its first use, the appliance may give off a slight odour: this is not harmful and it will disappear quickly. It has no effect on the functioning of your ActiFry.

Preparing food

Do not leave the measuring spoon inside the pan when cooking food.

- Place the food in the cooking pan, distributing it evenly, making sure that you respect the maximum quantity (see cooking tables p. 9 to 11) – **fig. 6**.
- Add the oil to the food with the spoon – **fig. 7**, distributing it evenly (see cooking tables p. 9 to 11 for the amount). (1 spoonful of oil = 14 ml of oil)
- Unlock the handle and fold it completely into its housing – **fig. 8**.
- Close the lid – **fig. 9**.
- Never exceed the maximum quantities of ingredients and liquids indicated in the instruction manual and in the recipe book.

Cooking

- This appliance is not suitable for recipes with a high-liquid content (eg. soups, cook-in sauces...).**
- Never turn on the appliance if the cooking pan is empty.**
- Do not overfill the cooking pan, never exceed the quantities indicated in the recipes and cooking tables or maximum food level mark (for liquid).**

Set the cooking time

- Press the timer setting button to set the time. Hold down the button until desired time is featured on the display – **fig. 10** (see cooking tables p. 9 to 11).
- Now release. The selected time (in minutes) is displayed and the countdown starts.
- If you make a mistake or to delete the selected time, hold down the button for 2 seconds then set the time again.

NOTE: the timer signals the end of the cooking but does not switch off the fryer.

Starting the cooking

When you open the lid, the appliance stops working.

- Press the On/Off switch, the cooking begins thanks to the hot air circulation inside the cooking enclosure – **fig.11**. The paddle rotates slowly in a clockwise direction.

Taking food out

- Once cooking is completed, the timer beeps. To stop the beeping signal, press the timer setting button – **fig.12**
- Press on On/Off to stop the appliance – **fig. 13** and open the lid.
- Lift the handle until you hear a “click” that it locks and take out the cooking pan – **fig. 14**.
- Serve at once.

To avoid any risk of burns do not touch the lid or any part other than the cool touch area.

Table of cooking times

The cooking times below are only a guide and may vary according to the variety and batch of potatoes used. We recommend using varieties such as King Edward and Maris Piper for chips and potato recipes.

Potatoes

	TYPE	QUANTITY	OIL	COOKING TIME
Chips standard thickness 13 mm x 13 mm length up to 9 cm	Fresh	1200 g**	1 spoonful oil	43 - 46 min
	Fresh	1000 g*	1 spoonful oil	40 - 45 min
	Fresh	750 g*	3/4 spoonful oil	35 - 37 min
	Fresh	500 g*	1/2 spoonful oil	28 - 30 min
	Fresh	250 g*	1/4 spoonful oil	24 - 26 min
Potatoes (quartered)	Fresh	1000 g*	1 spoonful oil	40 - 42 min
	Frozen	750 g	None	14 - 16 min
Diced potato	Fresh	1000 g*	1 spoonful oil	40 - 42 min
	Frozen	750 g	None	30 - 32 min
Chips	Frozen - suitable for deep frying only	750 g Standard 13 mm x 13 mm	None	35-40 min
	Frozen - 2 way or 3 way cook suitable for oven and grill (and deep frying).	750 g Thin 10 mm x 10 mm	None	30-32 min
		500 g American Style 8 mm x 8 mm	None	25-27 min

*Weight of unpeeled potatoes

IMPORTANT: To avoid damaging your appliance, never exceed the maximum quantities of ingredients and liquids indicated in the instruction manual and in the recipe leaflet.

** Only using the turnover ring - Depending on model

Other vegetables

	TYPE	QUANTITY	OIL	COOKING TIME
Courgettes	Fresh, in slices	750 g	1 spoonful oil + 150 ml cold water	25 - 35 min
Sweet peppers	Fresh, in slices	650 g	1 spoonful oil + 150 ml cold water	20 - 25 min
Mushrooms	Fresh, in quarters	650 g	1 spoonful oil	12 - 15 min
Tomatoes	Fresh, in quarters	650 g	1 spoonful oil + 150 ml cold water	10 - 15 min
Onions	Fresh, in rings	500 g	1 spoonful oil	15 - 25 min

Meat - Poultry

To add flavour to meat and poultry, mix some spices (such as paprika, curry, mixed herbs, thyme....) with the oil.

	TYPE	QUANTITY	OIL	COOKING TIME
Chicken nuggets	Fresh	750 g	None	18 - 20 min
	Frozen	750 g	None	18 - 20 min
	Frozen	12 pieces (160 g)	None	12 - 15 min
Chicken drumsticks	Fresh	4 to 6	None	30 - 32 min
Chicken legs	Fresh	2	None	30 - 35 min
Chicken breasts (boneless)	Fresh	6 (about 750 g)	None	10 - 15 min
Chinese Spring Rolls	Fresh	4 to 8 small	1 spoonful oil	10 - 12 min
Lamb chops	Fresh (2.5 cm to 3 cm thick)	2 to 6	None	20 - 25 min*
Pork chops	Fresh (2.5 cm thick)	2 to 3	None	18 - 23 min*
Pork fillet	Fresh	2 to 6 thin slices or strips	1 spoonful oil	12 - 15 min
Sausages	Fresh	4 to 8 (pricked)	None	10 - 12 min
Chilli Con Carne	Fresh (made from minced beef)	500 g	1 spoonful oil	30 - 40 min
Beef steak	Fresh (rump or sirloin cut into 1 cm thick strips)	600 g	None	8 - 10 min
Meatballs	Fresh	12 pieces	None	18 - 20 min

*Turn halfway through cooking

Fish - Shellfish

	TYPE	QUANTITY	OIL	COOKING TIME
Breaded scampi	Frozen	18 pieces (280 g)	None	10 min
Monkfish	Fresh cut in pieces	500 g	1 spoonful oil	20 - 22 min
Prawns	Cooked	400 g	None	10 - 12 min
Jumbo King prawns	Frozen and thawed	300 g (16 pieces)	None	12 - 14 min

	TYPE	QUANTITY	OIL	COOKING TIME
Bananas	Cut in slices	500 g (5 bananas)	1 spoonful oil + 1 spoonful brown sugar	4 - 6 min
	Wrapped in tinfoil	2 bananas	None	20 - 25 min
Cherries	Whole	Up to 1000 g	1 spoonful oil + 1 to 2 spoonful sugar	12 - 15 min
Strawberries	Cut in quarters if large or halves if small	Up to 1000 g	1 to 2 spoonful sugar	5 - 7 min
Apples	Cut in wedges	3	1 spoonful oil + 2 spoonful sugar	15 - 18 min
Pears	Cut in pieces	Up to 1000 g	1 to 2 spoonful sugar	8 - 12 min
Pineapple	Cut in pieces	1	1 to 2 spoonful sugar	8 - 12 min

ActiFry cooking hints and tips

- Do not add salt to chips while the chips are in the pan. Only add salt once the chips are removed from the appliance at the end of cooking.
- When adding dried herbs and spices to ActiFry, mix them with some oil or liquid. If you try sprinkling them directly into the pan they will just get blown around by the hot air system.
- Please note that strong coloured spices may slightly stain the paddle and parts of the appliance. This is normal.
- For best results, use finely chopped garlic instead of crushed garlic to avoid it adhering to the central paddle.
- If using onions in ActiFry recipes, they are best thinly sliced instead of chopped as they cook better. Separate the onion rings before adding them to the pan and give them a quick stir so that they are evenly distributed.
- With meat and poultry dishes, stop the appliance and stir the pan once or twice during cooking so that the food on top does not dry out and the dish thickens evenly.
- Prepare vegetables in small pieces or stir fry size to ensure they cook through.
- This appliance is not suitable for recipes with a high-liquid content (eg. soups, cook-in sauces...).
- For best results, the best place to store potatoes is in a dark cellar or cool cupboard (between 6 and 8°C), away from the light.
- Remember that there can be seasonal variations in the quality of potatoes used, even for the varieties of potato we recommend (Rooster, Maris Piper or King Edwards) these can also be affected by the weather ie long, wet summers will produce potatoes with a higher water content than normal which may produce less crisp results. If this happens, try changing the potatoes you are using.
- The way the potatoes are stored in Supermarkets can also affect the cooking result. Try buying potatoes from a different supermarket or source.
- The chips must be perfectly dry before putting them in the pan otherwise they will not turn crispy. Wipe off any excess ice from frozen chips.
- With ActiFry, you can use a very wide variety of oils:
- Standard oils : olive oil, grape seed oil, corn oil, groundnut (peanut) oil, sunflower oil, soya oil*
- Flavoured oils : oils infused with aromatic herbs, garlic, chilli, lemon...
- Speciality oils : hazelnut*, sesame*...

(*cook according to the manufacturers instructions)

Easy cleaning

Cleaning the appliance

- Leave it to cool down completely before cleaning.
- Open the lid – **fig. 1** and lift the latch to take off the lid – **fig. 2**.
- Lift the handle to the horizontal position until you hear a “click” as it locks – **fig. 3**.
- Take out the cooking pan.
- Remove the ring by releasing the clips from the edge of the pan and pushing it upwards*.
- Remove the paddle by pushing the release button – **fig. 4a**.
- Remove the filter (on parts diagram no. 12) by pulling the top and wash it.
- All the removable parts are dishwasher safe – **fig. 5** or can be washed with a soft sponge and washing up liquid.
- Clean the base of the appliance using a damp cloth and washing up liquid.
- Rinse and dry parts carefully before putting them back together.
- If food gets stuck or burnt on to the pan or paddle, leave them to soak in warm water before cleaning.
- We guarantee that the coating of the cooking pan complies with regulations concerning materials in contact with foodstuffs.

Never immerse the base in water.

Do not use harsh or abrasive cleaning products or scourers.

The removable filter must be cleaned regularly.

Do not use metal utensils in the cooking pan or when serving food

Timer battery

This appliance uses a button battery – L1154.

- To change the battery remove the control panel with a small flat bladed jewellers screw driver. Prise the control panel up by inserting the screwdriver into the gap at the top of the panel. Remove the white battery cover and replace the battery – fig 15. To protect the environment do not throw the old battery in your regular waste but take it to a suitable collection point.
- Insert a new battery, put the battery cover back on and clip the control panel back on.

*Depending on model

If your fryer is not working correctly

PROBLEMS	CAUSES	SOLUTIONS
The appliance is not working.	The appliance is not plugged in.	Check that the appliance is plugged in correctly.
	The On-Off switch is not fully pressed down.	Press on the On/Off switch.
	You have pressed down the On-Off switch but the appliance is not working.	Close the lid.
	The motor is running but the appliance does not heat.	Contact the consumer service.
	The paddle does not turn.	Check that the paddle is correctly positioned. If the problem continues, contact the consumer service.
The removable paddle doesn't stay in place.	The mixing paddle is not locked or the pan has been damaged.	Check that the locking lever has been pushed down fully or is not damaged. Check that the cooking pan where the paddle sits has not been damaged. If so, contact the consumer service.
Food is not cooking evenly.	The paddle has not been installed.	Fit the paddle.
	The food has not been cut in regular size pieces or the pan has been damaged.	Cut food to the same size.
	The chips have not been cut in regular size pieces.	Cut the chips to the same size.
	The paddle has been installed correctly but it does not turn.	Check that it has been pushed down and clicked in position. If the problem continues, contact your point of purchase.
The chips are not crispy enough.	The wrong variety of potatoes has been used.	Choose a variety of potato recommended for chips.
	The potatoes are insufficiently washed and/or not completely dried.	Wash the potatoes for a long time to remove excess starch, then drain and dry them before cooking. They must be completely dry.
	The chips are too thick.	Cut the chips thinner. The maximum chips dimensions are 13mm x 13 mm.
	There is not enough oil for the quantity of chips.	Increase the oil quantity (see cooking tables p. 9 to 11).
	The filter is obstructed.	Clean the removable filter.
The chips break up during the cooking.	The potatoes used are recently harvested and hence have a high water content.	Reduce the quantity of potatoes down to 800 g and adjust the cooking time.
	The potatoes may not have been stored correctly in the supermarket.	Purchase your potatoes from a different source.
The food stays on the edge of the cooking pan.	The cooking pan is too full. There is too much liquid in the cooking pan.	Respect the maximum quantities indicated in the cooking tables.
Cooking liquids have flowed into the base of the appliance.	The paddle is not positioned correctly or the seal of the paddle is defective.	Make sure that the paddle is correctly positioned. If the problem continues, contact the consumer service. Do not use ActiFry for making soups or recipes with a high liquid content.
The timer does not work.	The battery is dead.	Change the battery (see fig. 15).
The appliance is unusually noisy.	You suspect the motor is not working correctly.	Contact the consumer service.
The paddle stops turning during cooking.	The paddle is not positioned correctly.	Using an oven glove, push the paddle downward until it clicks into place. If this does not work, contact the consumer service.

