

Tefal[®]

ACCESSIMO

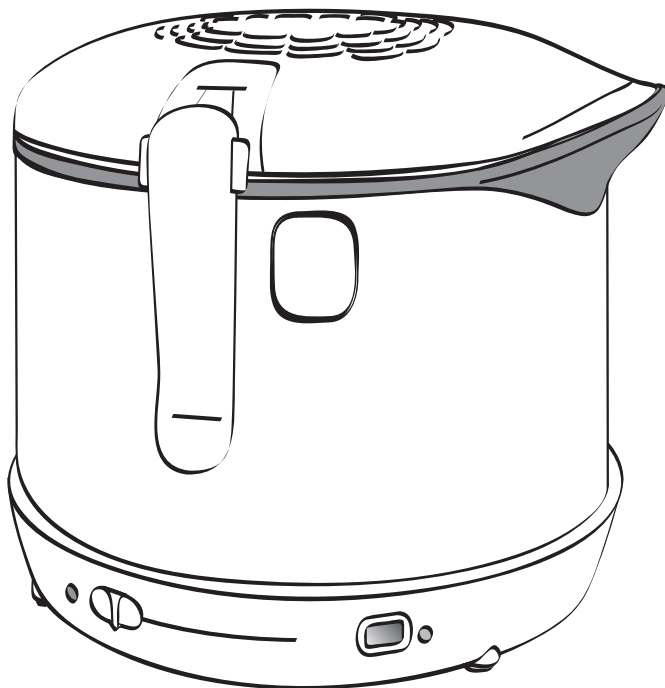

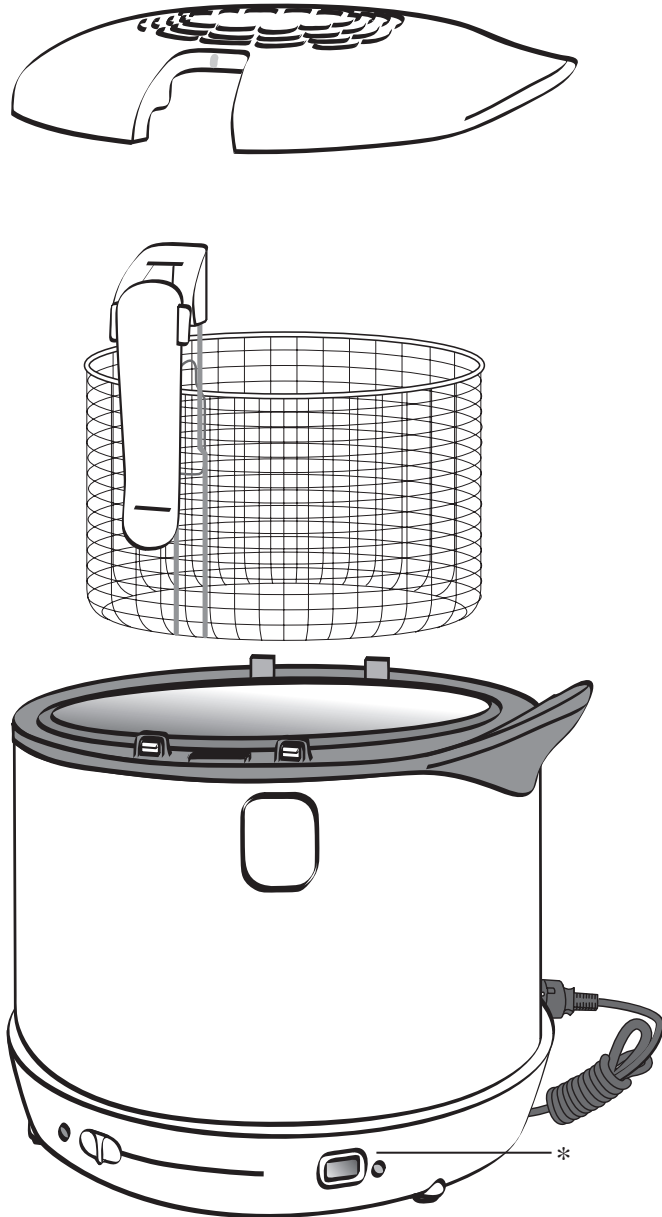

*selon modèle • depending on model • je nach Modell • a seconda del modello • según modelo • consoante os modelos • Ανάλογα με το μοντέλο • В зависимости от модели • Залежно від моделі • zależnie od modelu • az egyes modellek szerint • podle modelů • podľa modelov • В зависимости от модели • În funcție de model • modellere göre • Зависно од модела • zavisno od modela • Ölede na model • بحسب الموديل • بحسب مدل

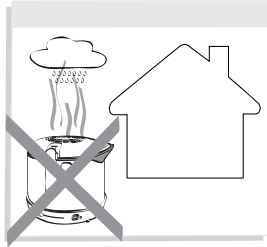
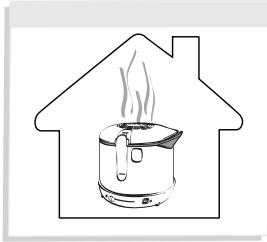

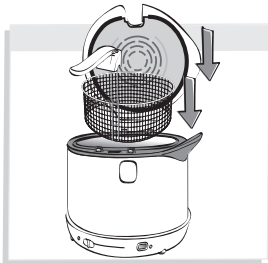
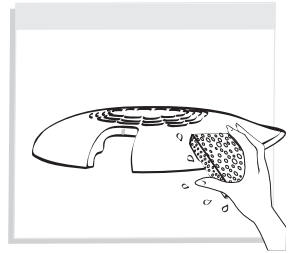
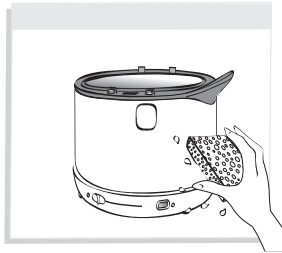
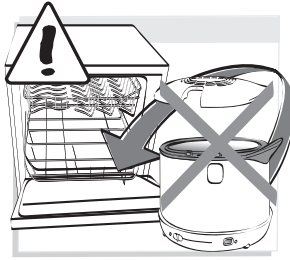
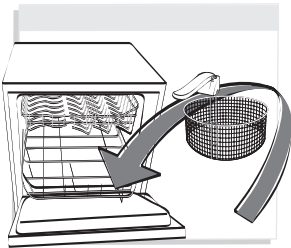
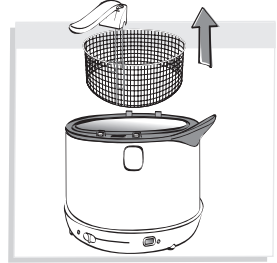
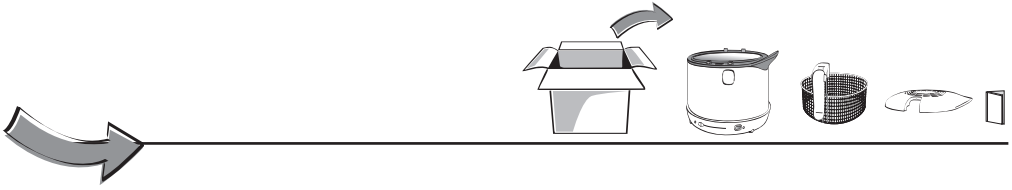



Min 2L

Max 2,2L

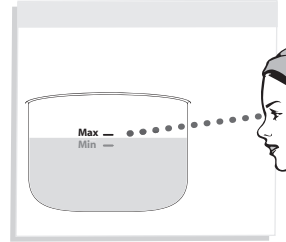

Min 1 750 g

Max 2 000 g

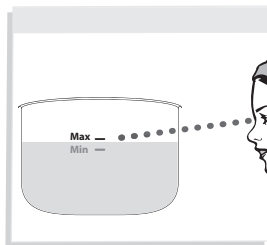
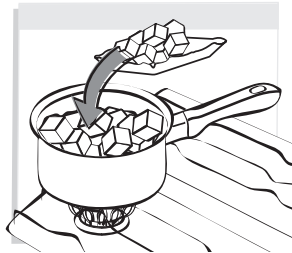

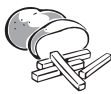
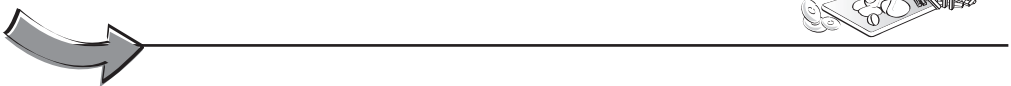

Max 1000 g
500 g

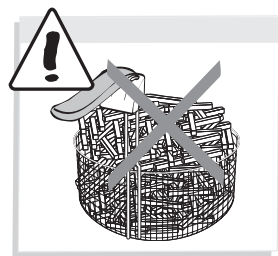
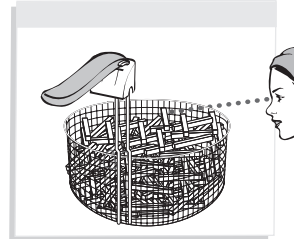
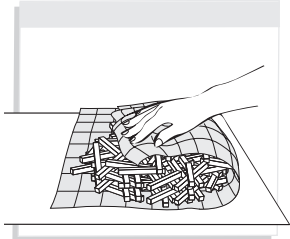



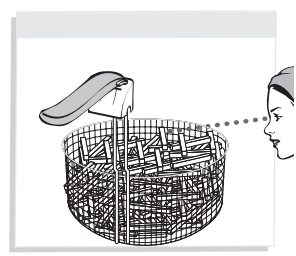
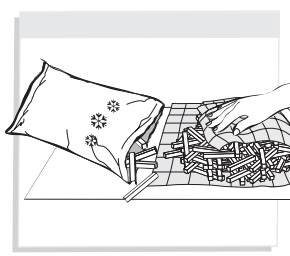

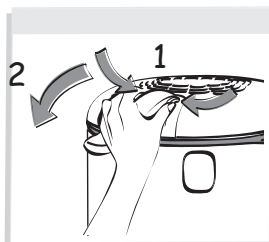
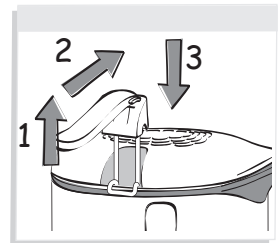
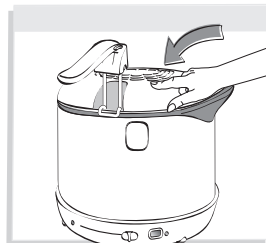
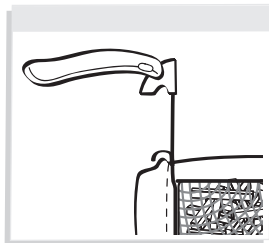
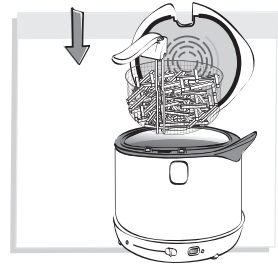
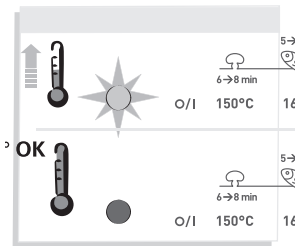
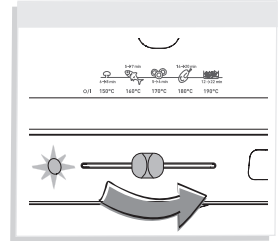
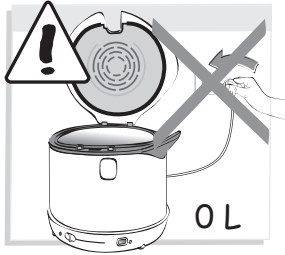













Max 750 g
380 g







	Nb		 °C	
		1000g	① 160°C	8-10 min.
			② 190°C	4-5 min.
		1000g	190°C	12-14 min.
		600g	170°C	10-12 min.
		500g	190°C	7-9 min.
		3-4	180°C	16-18 min.
		2	160°C	6-8 min.
		200g	150°C	6-8 min.
		4	180°C	11-13 min.
		8	180°C	10-12 min.
		5	170°C	5-7 min.
* * *	Nb		 °C	
		750g	190°C	9-11 min.
		750g	170°C	10-12 min.
		380g	170°C	7-9 min.
		3-4	190°C	16-20 min.
		2	160°C	5-7 min.
		200g	190°C	4-5 min.
		1 Kg	190°C	5-7 min.
		6	190°C	4-6 min.

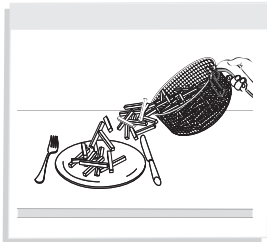
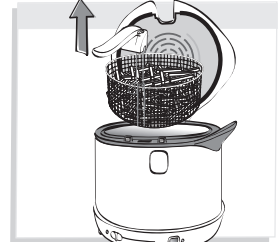
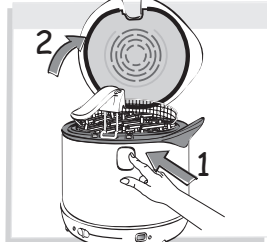
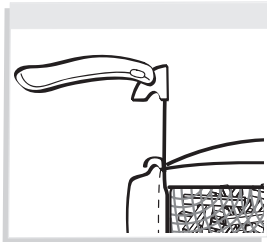
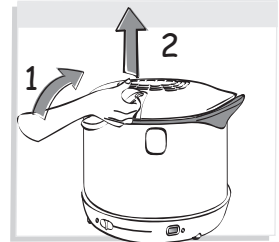
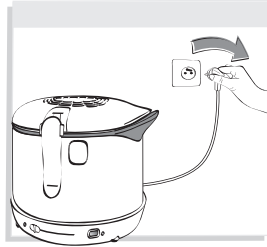
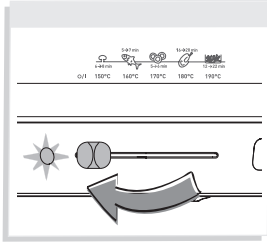

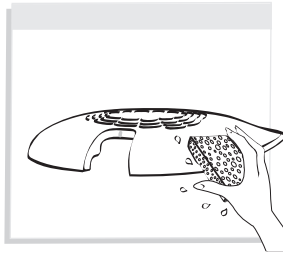
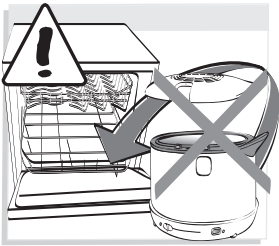
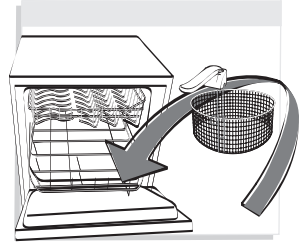
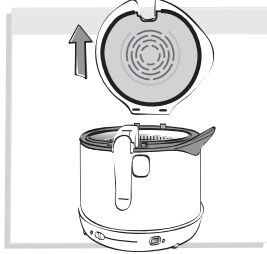
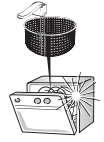

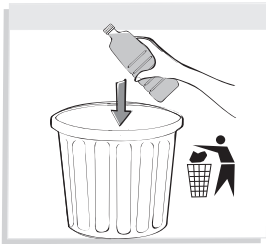
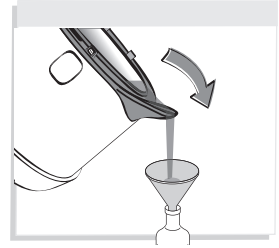
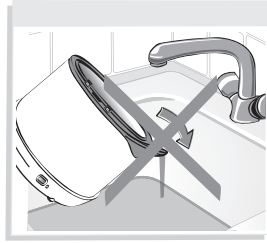

Référence : NC00012305
Conception : www.batoteam.fr

