

Tefal[®]

EASY PRO

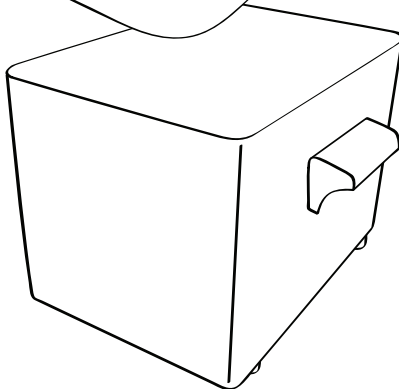

www.tefal.com

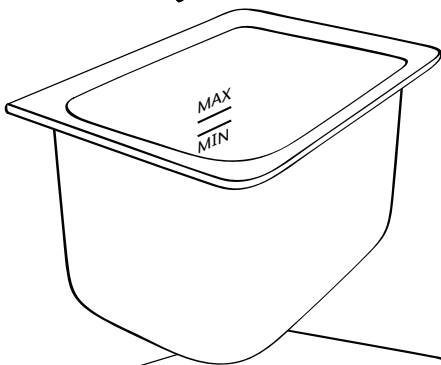
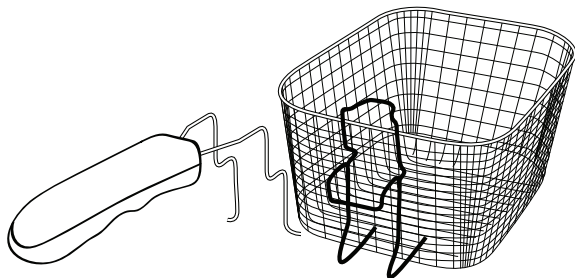
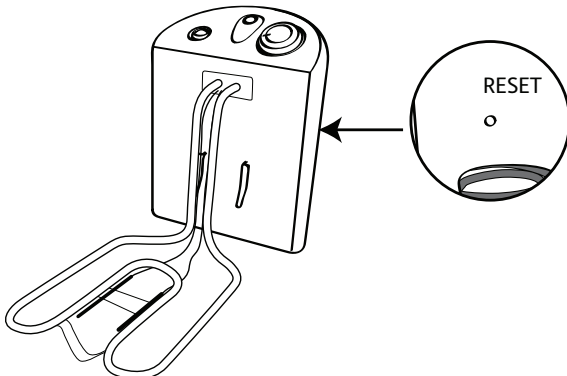
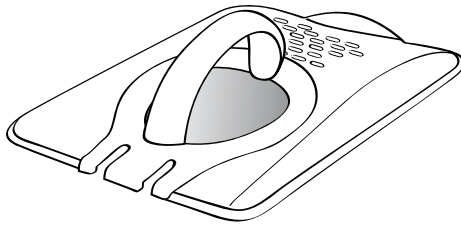

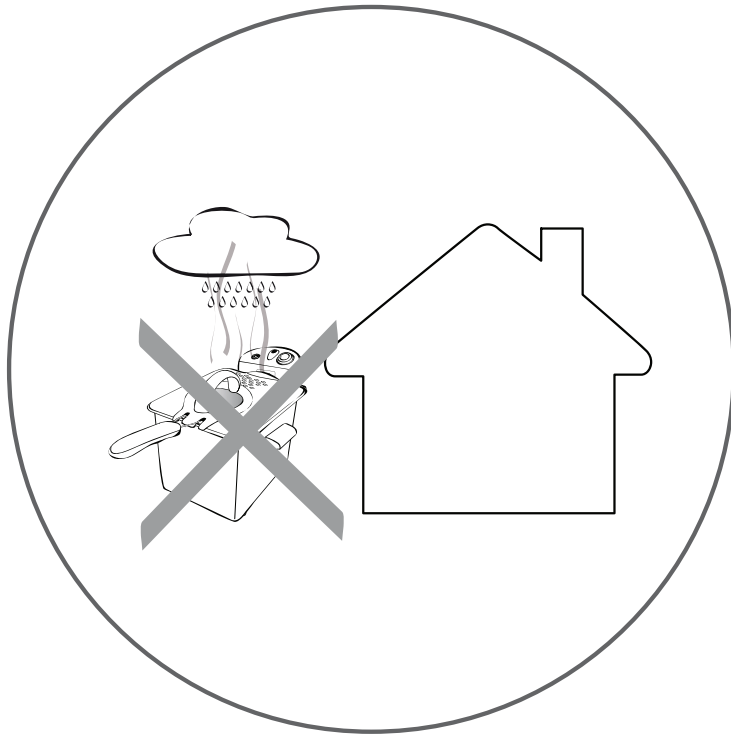
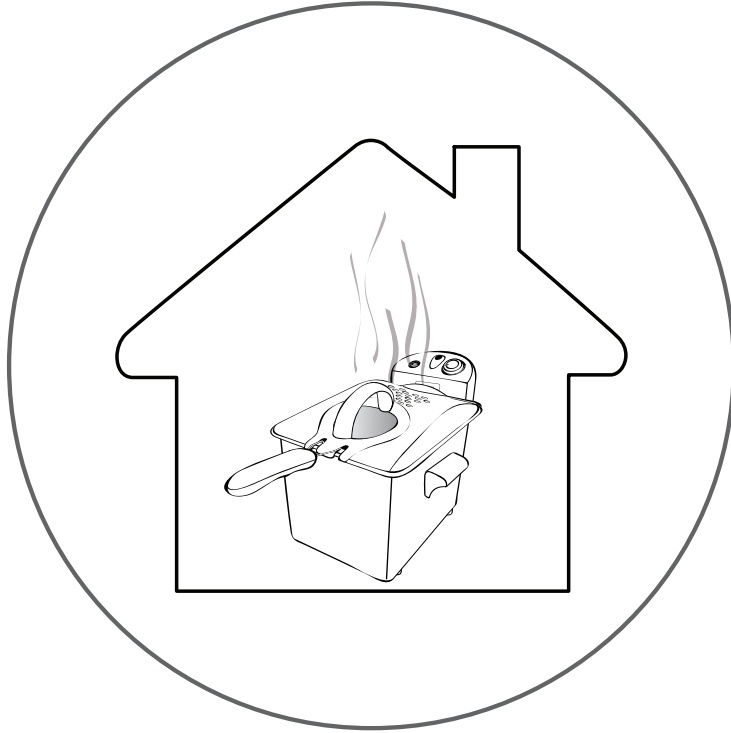

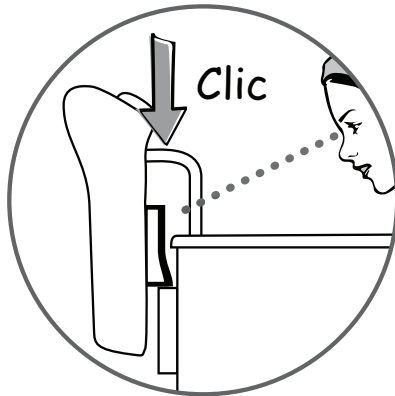
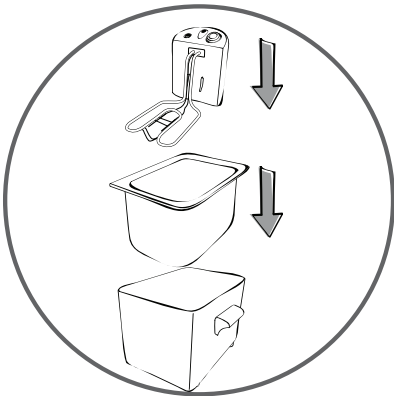
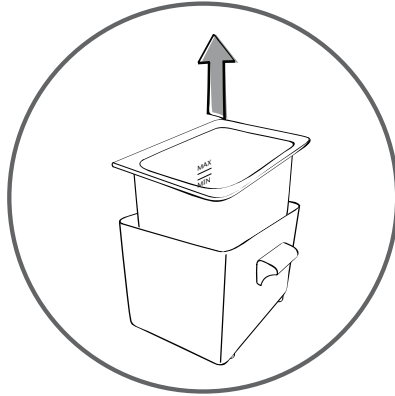
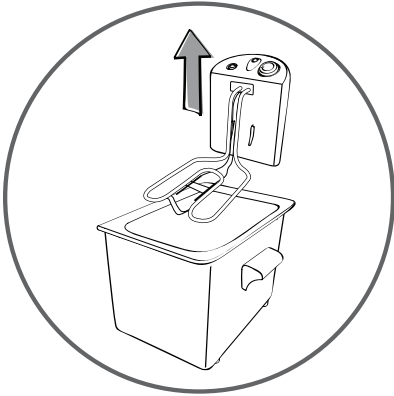
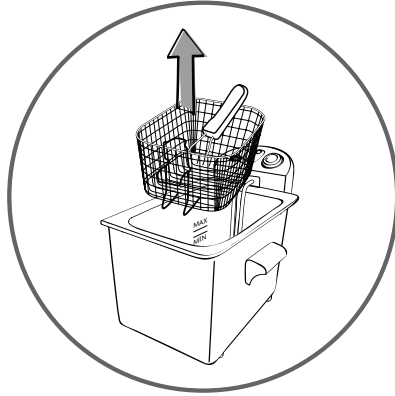
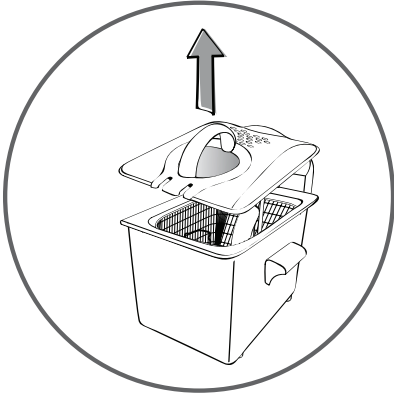
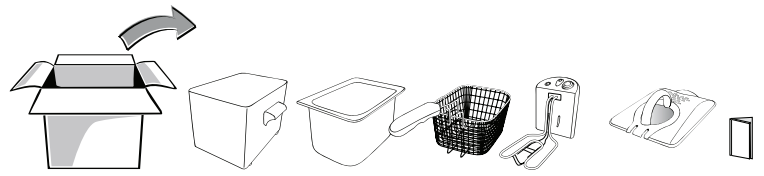



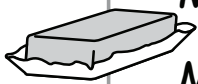
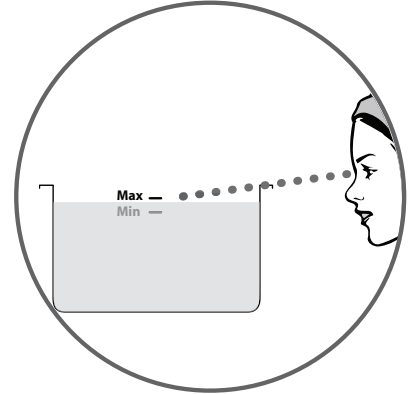
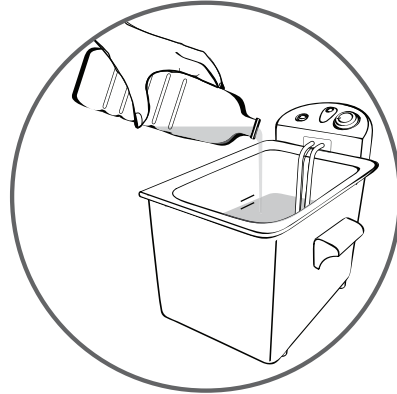

Min 2,8L
Max 3L



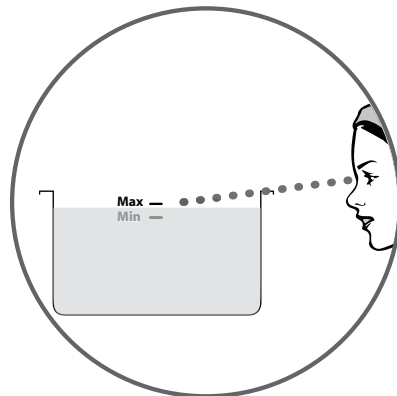
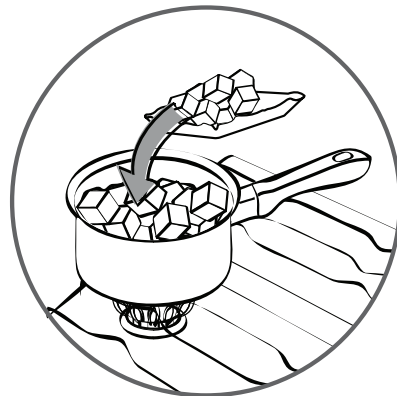

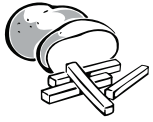
Min 2550g
Max 2700g



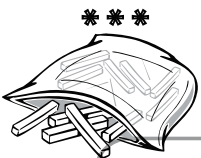
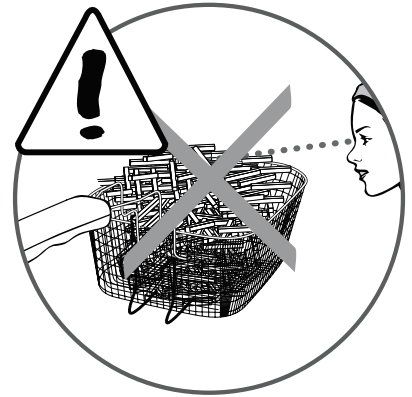
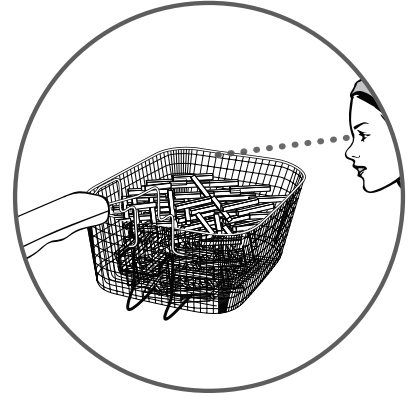
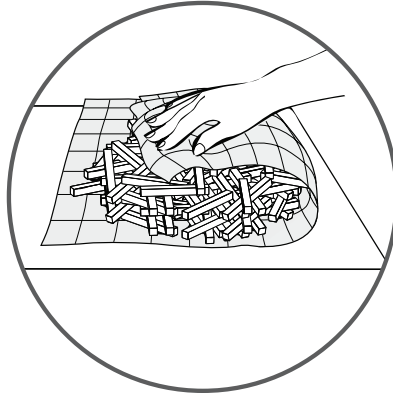

Max	1000g
	600g



Max	900g
	450g

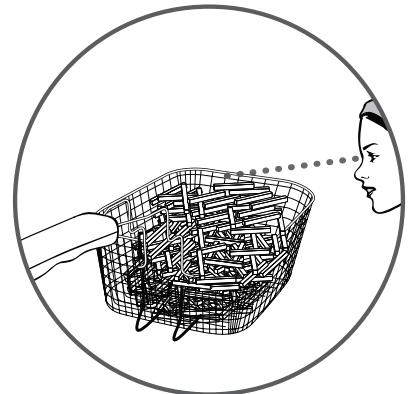
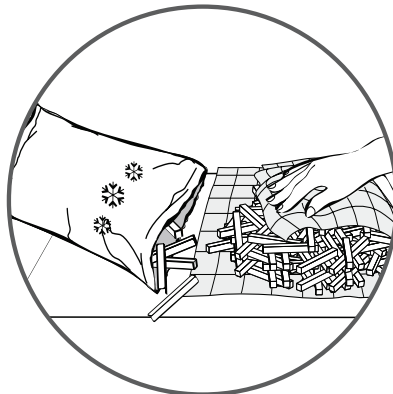

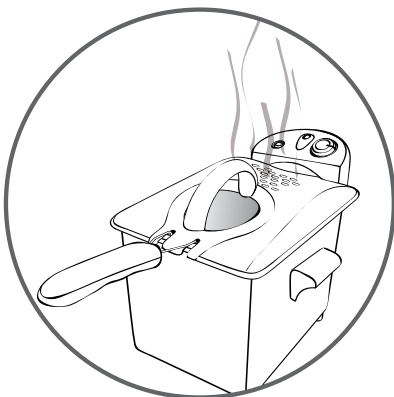
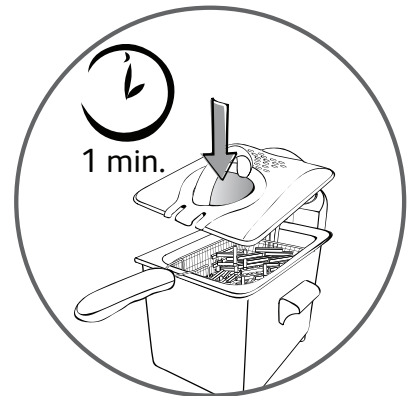
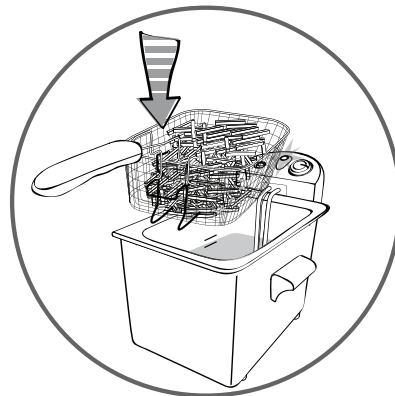
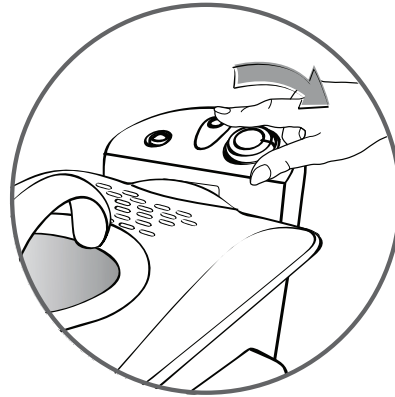
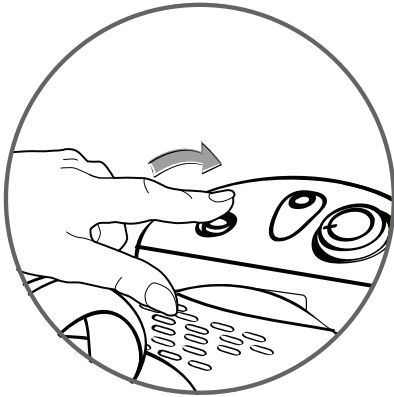
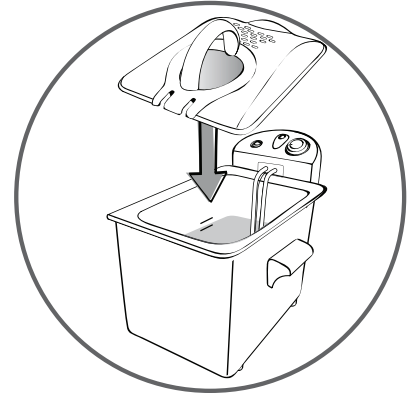
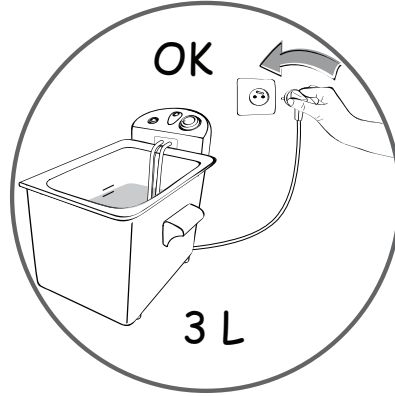

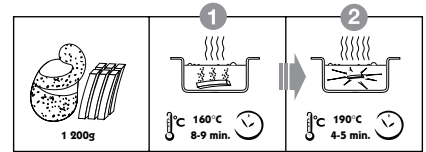

	Nb		°C	
		1 200g	1) 160°C	8-9 min.
			2) 190°C	4-5 min.
		1 000g	190°C	11-12 min.
		600g	170°C	9-10 min.
	8		180°C	15-16 min.
		400g	160°C	4-5 min.
		400g	150°C	5-7 min.
	6		170°C	4-5 min.
* * *	Nb		°C	
		900g	190°C	10-11 min.
		750g	190°C	8-9 min.
		450g	190°C	5-6 min.
		1 200g	190°C	7-8 min.
		450g	190°C	6-8 min.
	8/9		190°C	7-8 min.

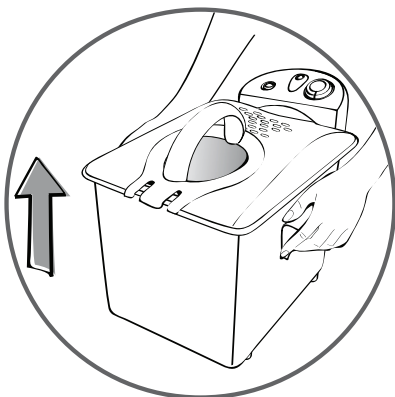
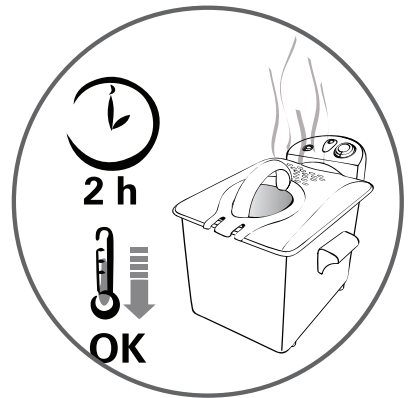
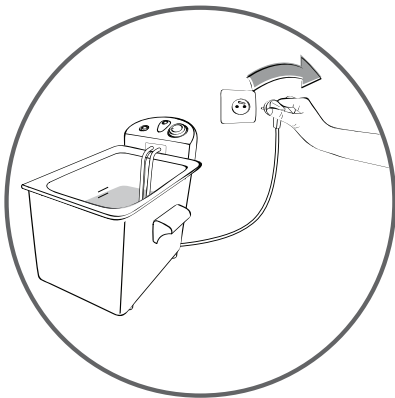
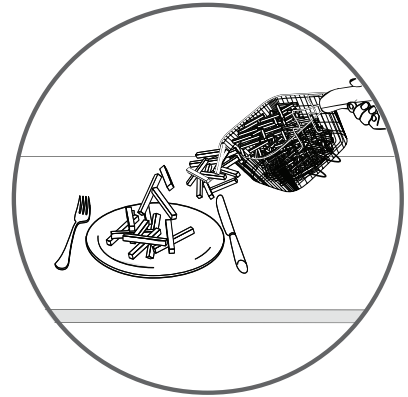
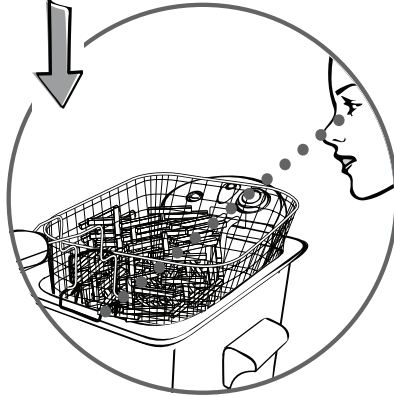
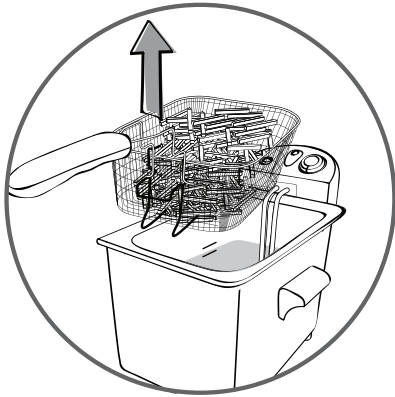
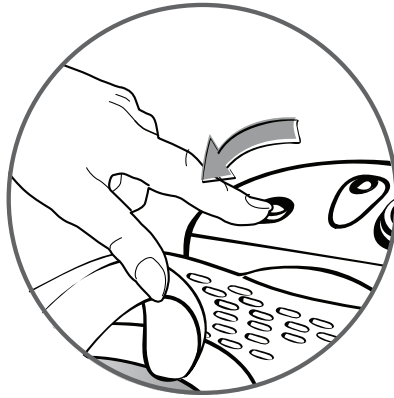

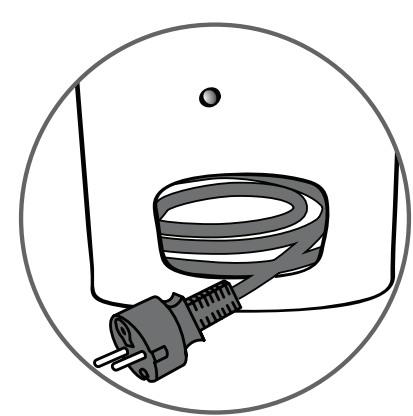
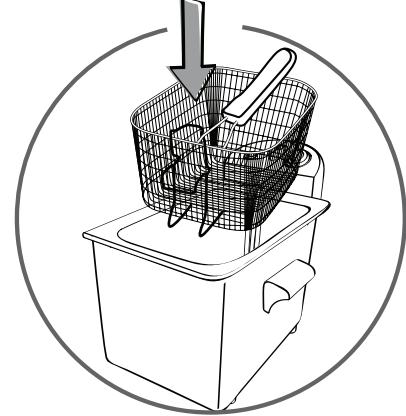
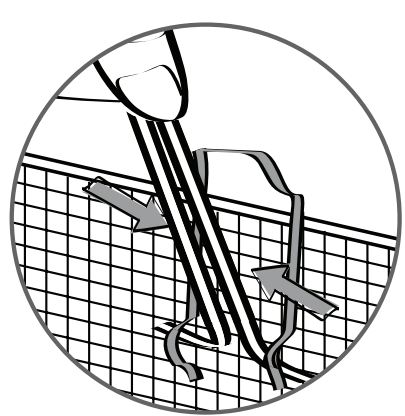
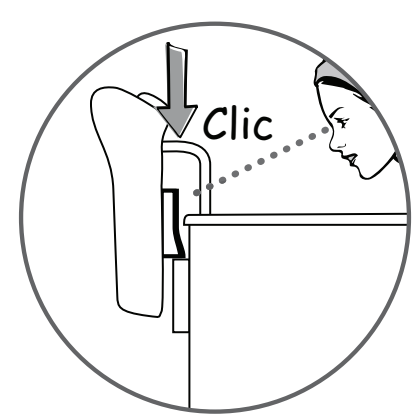
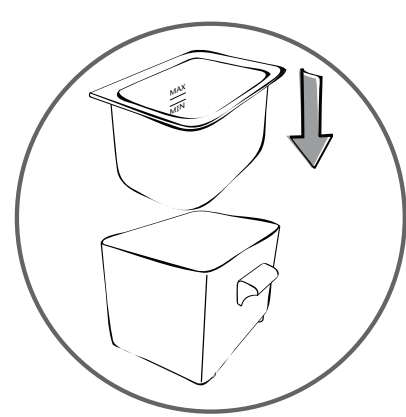
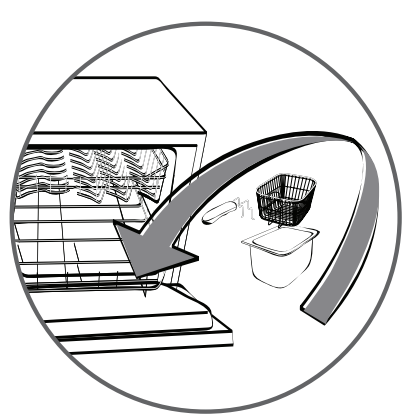
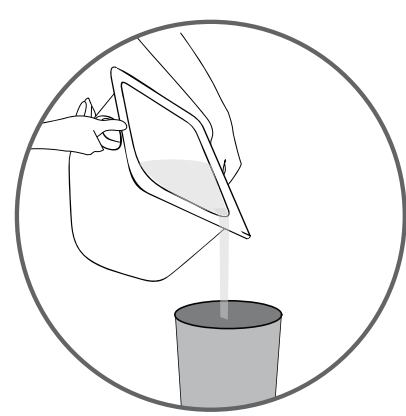
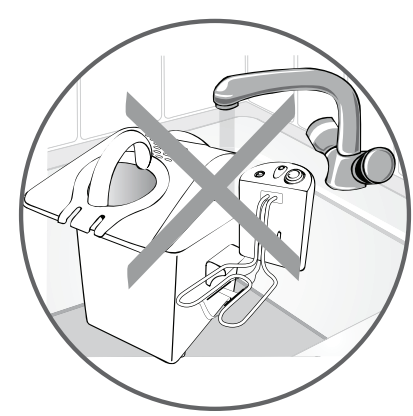
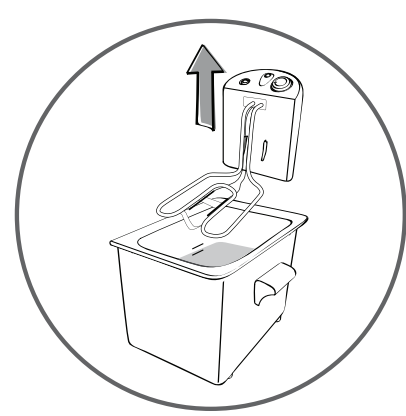
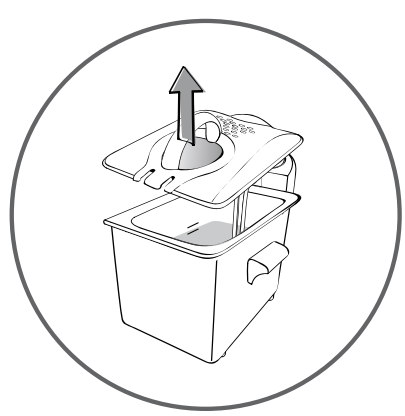

RESET

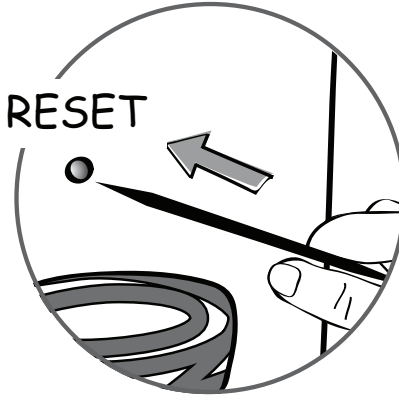
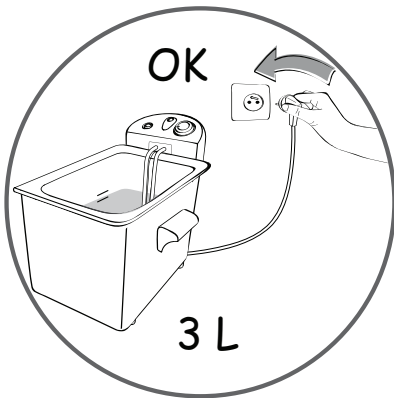
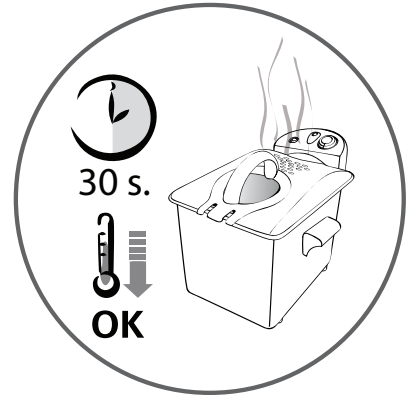
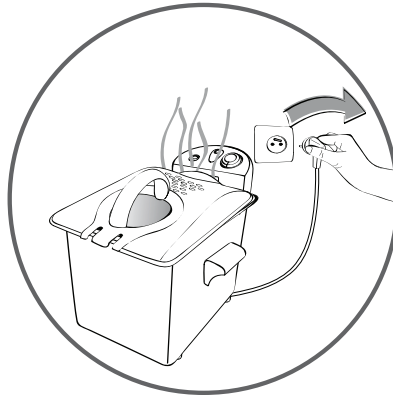
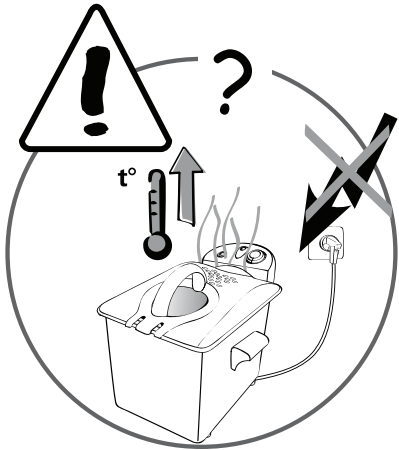



10

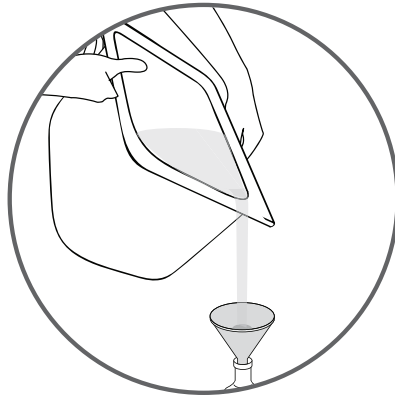
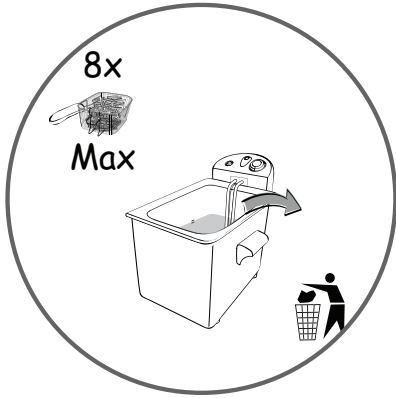

11

